

Ultra-Fast Recovery Diodes 30A FRED

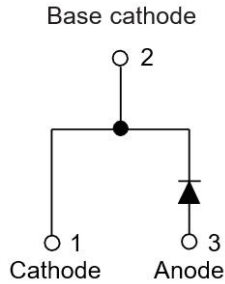
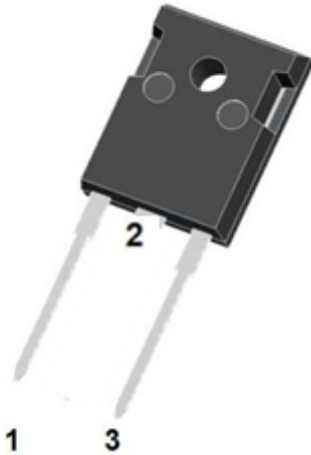

Features

- Adopt FRED chip
- Low forward Voltage drop
- Fast reverse recovery time
- High frequency operation
- High purity, high temperature epoxy encapsulation for enhanced mechanical strength and moisture resistance
- Guard ring for enhanced ruggedness and long term reliability

Typical Applications

- Typical applications are in switching power supplies, converters, freewheeling diodes, and reverse battery protection.

Mechanical Data

- **Package:** TO-247AC
Molding compound meets UL 94 V-0 flammability rating, RoHS-compliant
- **Terminals:** Tin plated leads, solderable per J-STD-002 and JESD22-B102
- **Polarity:** As marked

■ Maximum Ratings ($T_j=25^\circ\text{C}$ Unless otherwise specified)

PARAMETER	SYMBOL	UNIT	MUR3060PL
Device marking code			MUR3060PL
Repetitive Peak Reverse Voltage	VRRM	V	600
Average Rectified Output Current @60Hz sine wave, R-load, T_c (FIG.1)	I_O	A	30
Surge(Non-repetitive)Forward Current @60Hz half sine-wave, 1 cycle, $T_a=25^\circ\text{C}$	IFSM	A	300
Current Squared Time @ $1\text{ms} \leq t \leq 8.3\text{ms}$ $T_j=25^\circ\text{C}$,	I^2t	A^2s	373
Single Pulse Avalanche Energy @ $T_p=40\mu\text{s}$, $T_j=25^\circ\text{C}$, $L=15\text{mH}$	EAS	mJ	210
Storage Temperature	T_{stg}	$^\circ\text{C}$	-55 ~ +175
Junction Temperature	T_j	$^\circ\text{C}$	-55 ~ +175
Typical Junction capacitance @4V,1MHz	C_j	pF	160



MUR3060PL-B1-W5094HF

■ Electrical Characteristics

PARAMETER	SYMBOL	UNIT	TEST CONDITIONS	Min	Typ	Max	
Instantaneous forward voltage drop per diode	V_{FM}	V	$I_{FM}=30.0A$ @ $T_j=25^\circ C$	-	2.0	2.50	
			$I_{FM}=30.0A$ @ $T_j=125^\circ C$	-	1.65	2.0	
DC reverse current at rated DC blocking voltage per diode	I_{RRM1}	uA	$V_{RM}=V_{RRM}$ $T_j=25^\circ C$	-	-	5.0	
	I_{RRM2}		$V_{RM}=V_{RRM}$ $T_j=125^\circ C$	-	-	200	
Reverse Recovery Time	T_{rr}	ns	$I_F=0.5A$ $I_{RM}=1A$ $I_{RR}=0.25A$ $T_j=25^\circ C$	-	28	50	
				$T_j=25^\circ C$	-	60.5	-
				$T_j=125^\circ C$	-	96.98	-
Peak recovery current	I_{RRM}	A	$I_F=30A$ $di/dt=-200A/us$ $V_{RM}=400V$	$T_j=25^\circ C$	-	3.53	-
				$T_j=125^\circ C$	-	11.3	-
Reverse recovery charge	Q_{rr}	nC	$T_j=25^\circ C$	$T_j=25^\circ C$	-	106.7	-
				$T_j=125^\circ C$	-	537.25	-

■ Thermal Characteristics ($T_j=25^\circ C$ Unless otherwise specified)

PARAMETER		SYMBOL	UNIT	MUR3060PL
Thermal Resistance	Between junction and case	$R_{\theta J-C}$	$^\circ C/W$	1.0
	Between junction and Air	$R_{\theta J-A}$	$^\circ C/W$	50

■ Characteristics(Typical)

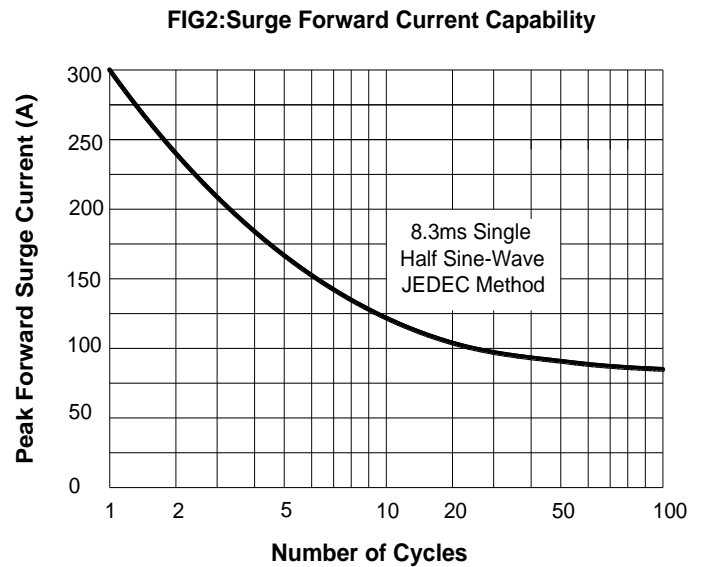
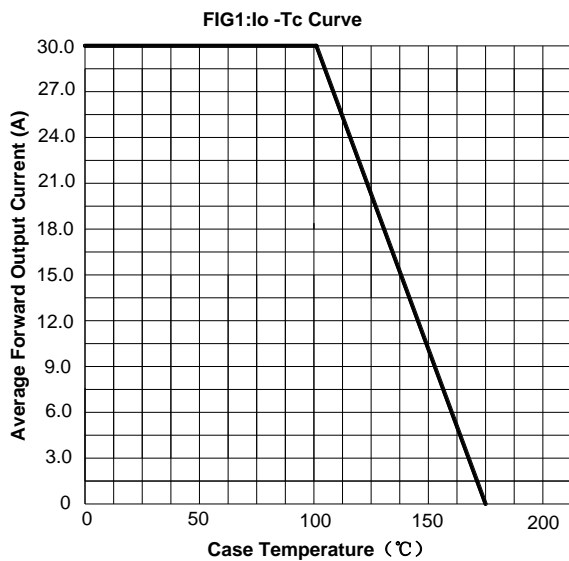



MUR3060PL-B1-W5094HF

FIG3: Forward Voltage

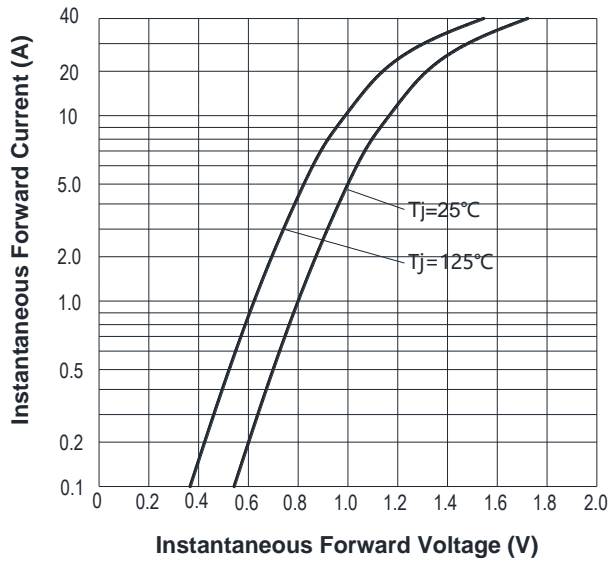

FIG.4: Instantaneous Reverse Characteristics

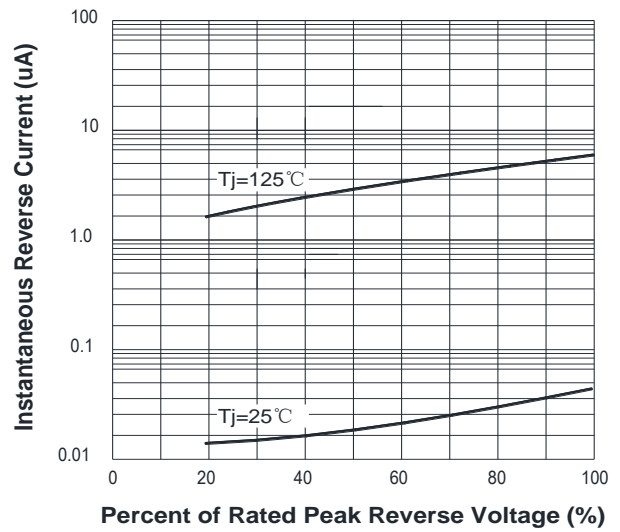
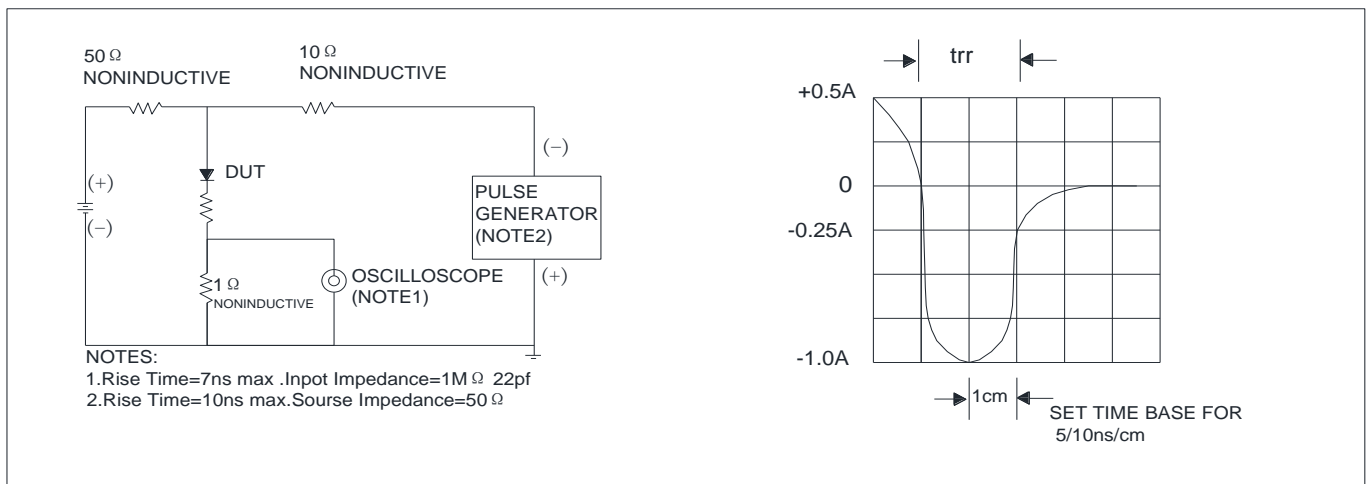

FIG.5: Diagram of circuit and Testing wave form of reverse recovery time





MUR3060PL-B1-W5094HF

■ Outline Dimensions

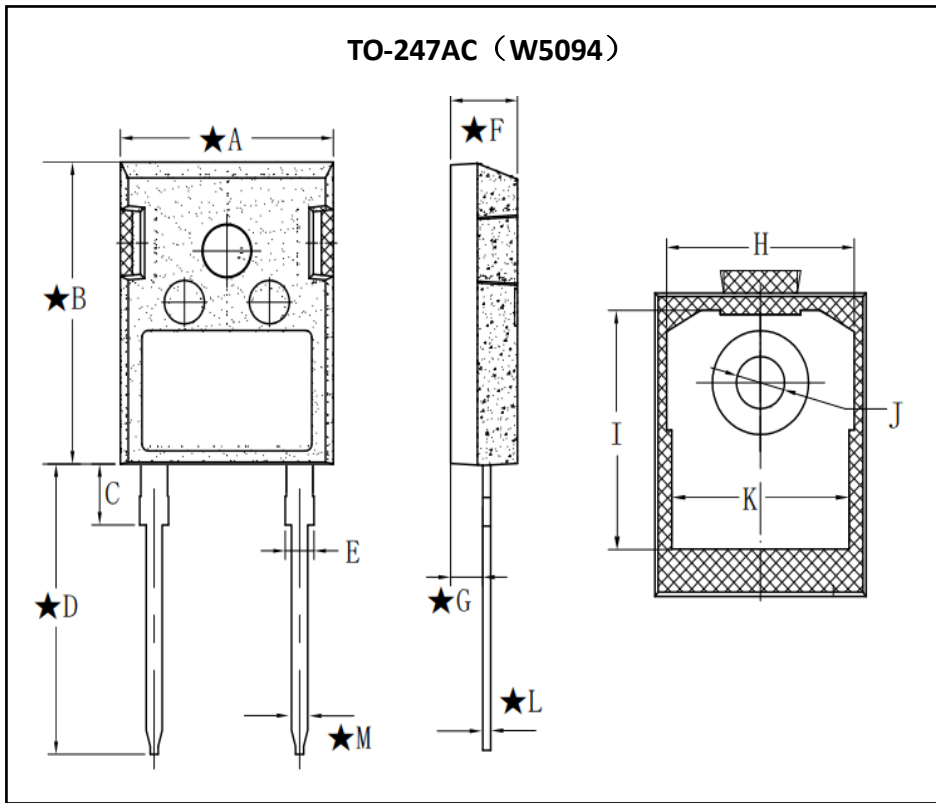

TO-247AC		
Dim	Min	Max
A	15.72	16.12
B	20.7	21.1
C	4.02	4.42
D	19.9	20.3
E	2.0	2.3
F	4.8	5.2
G	2.3	2.5
H	TYP 14.02	
I	TYP 16.55	
J	3.5	3.7
K	TYP 13.26	
L	0.58	0.62
M	1.15	1.25



MUR3060PL-B1-W5094HF

Disclaimer

The information presented in this document is for reference only. Yangzhou Yangjie Electronic Technology Co., Ltd. reserves the right to make changes without notice for the specification of the products displayed herein to improve reliability, function or design or otherwise.

The product listed herein is designed to be used with ordinary electronic equipment or devices, and not designed to be used with equipment or devices which require high level of reliability and the malfunction of which would directly endanger human life (such as medical instruments, transportation equipment, aerospace machinery, nuclear-reactor controllers, fuel controllers and other safety devices), Yangjie or anyone on its behalf, assumes no responsibility or liability for any damages resulting from such improper use of sale.

This publication supersedes & replaces all information previously supplied. For additional information, please visit our website [http:// www.21yangjie.com](http://www.21yangjie.com) , or consult your nearest Yangjie's sales office for further assistance.