

N-Channel Enhancement Mode Field Effect Transistor

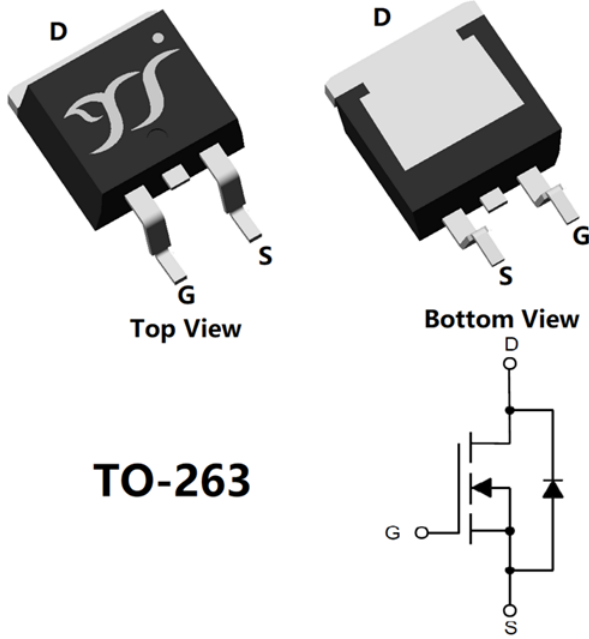

TO-263

Product Summary

- V_{DS} 150V
- I_D 117A
- $R_{DS(ON)}$ (at $V_{GS}=10V$) $<6.8m\Omega$
- 100% EAS Tested
- 100% ∇V_{DS} Tested

General Description

- Split gate trench MOSFET technology
- Excellent package for heat dissipation
- High density cell design for low $R_{DS(ON)}$
- Moisture Sensitivity Level 1
- Epoxy Meets UL 94 V-0 Flammability Rating
- Halogen Free

Applications

- Power switching application
- Uninterruptible power supply
- DC-DC convertor

■ Absolute Maximum Ratings ($T_J=25^\circ C$ unless otherwise noted)

Parameter			Symbol	Limit	Unit
Drain-source Voltage			V_{DS}	150	V
Gate-source Voltage			V_{GS}	± 20	V
Continuous Drain Current (Note 1,2)	Steady-State	$T_A=25^\circ C, V_{GS}=10V$	I_D	14.9	A
		$T_A=100^\circ C, V_{GS}=10V$		10.5	
Continuous Drain Current (Note 1,3)	Steady-State	$T_C=25^\circ C, V_{GS}=10V$		117	
		$T_C=100^\circ C, V_{GS}=10V$		82	
Pulsed Drain Current	$T_C=25^\circ C, t_p \leq 10\mu s$		I_{DM}	468	A
Avalanche Energy			EAS	400	mJ
Total Power Dissipation (Note 1,2)	Steady-State	$T_A=25^\circ C$	P_D	3.7	W
		$T_A=100^\circ C$		1.8	
Total Power Dissipation (Note 1,3)	Steady-State	$T_C=25^\circ C$		230	
		$T_C=100^\circ C$		115	
Junction and Storage Temperature Range			T_J, T_{STG}	-55~+175	$^\circ C$

■ Thermal Resistance

Parameter		Symbol	Typ	Max	Units
Thermal Resistance Junction-to-Ambient (Note 2)	Steady-State	$R_{\theta JA}$	32	40	$^\circ C/W$
Thermal Resistance Junction-to-Case	Steady-State	$R_{\theta JC}$	0.54	0.65	

■ Ordering Information (Example)

PREFERRED P/N	PACKING CODE	Marking	MINIMUM PACKAGE(pcs)	INNER BOX QUANTITY(pcs)	OUTER CARTON QUANTITY(pcs)	DELIVERY MODE
YJB6D8G15H	F2	YJB6D8G15H	800	/	8000	13" reel



YJB6D8G15H

■ Electrical Characteristics ($T_J=25^\circ\text{C}$ unless otherwise noted)

Parameter	Symbol	Conditions	Min	Typ	Max	Units
Static Parameter						
Drain-Source Breakdown Voltage	BV_{DSS}	$V_{GS}=0V, I_D=250\mu A$	150	-	-	V
		$V_{GS}=0V, I_D=1mA$	150	-	-	V
Zero Gate Voltage Drain Current	I_{DSS}	$V_{DS}=150V, V_{GS}=0V$	-	-	1	μA
		$V_{DS}=150V, V_{GS}=0V, T_J=150^\circ\text{C}$	-	-	100	
Gate-Body Leakage Current	I_{GSS}	$V_{GS}=\pm 20V, V_{DS}=0V$	-	-	± 100	nA
Gate Threshold Voltage	$V_{GS(th)}$	$V_{DS}=V_{GS}, I_D=250\mu A$	2.4	3	3.6	V
Static Drain-Source On-Resistance	$R_{DS(on)}$	$V_{GS}=10V, I_D=50A$	-	5.7	6.8	m Ω
Diode Forward Voltage	V_{SD}	$I_S=50A, V_{GS}=0V$	-	0.86	1.2	V
Gate resistance	R_G	$f=1\text{MHz}$	-	0.6	-	Ω
Maximum Body-Diode Continuous Current	I_S		-	-	117	A
Dynamic Parameters						
Input Capacitance	C_{iss}	$V_{DS}=75V, V_{GS}=0V, f=1\text{MHz}$	-	6280	-	pF
Output Capacitance	C_{oss}		-	470	-	
Reverse Transfer Capacitance	C_{rss}		-	9	-	
Switching Parameters						
Total Gate Charge	Q_g	$V_{GS}=10V, V_{DS}=75V, I_D=50A$	-	75	-	nC
Gate-Source Charge	Q_{gs}		-	25.3	-	
Gate-Drain Charge	Q_{gd}		-	12.5	-	
Reverse Recovery Charge	Q_{rr}	$I_F=50A, di/dt=100A/\mu s$	-	217	-	nC
Reverse Recovery Time	t_{rr}		-	97.4	-	ns
Turn-on Delay Time	$t_{D(on)}$	$V_{GS}=10V, V_{DD}=75V, I_D=50A$ $R_{GEN}=2.7\Omega$	-	4.4	-	ns
Turn-on Rise Time	t_r		-	24.6	-	
Turn-off Delay Time	$t_{D(off)}$		-	38.1	-	
Turn-off Fall Time	t_f		-	9.5	-	

Note:

- The entire application environment impacts the thermal resistance values shown, they are not constants and are only valid for the particular conditions noted.
- The value of $R_{\theta JA}$ is measured with the device mounted on the 40mm*40mm*1.1mm single layer FR-4 PCB board with 1 in² pad of 2oz. Copper, in the still air environment with $T_A=25^\circ\text{C}$. The maximum allowed junction temperature of 175°C . The value in any given application depends on the user's specific board design.
- Thermal resistance from junction to soldering point (on the exposed drain pad).



YJB6D8G15H

Typical Electrical and Thermal Characteristics Diagrams

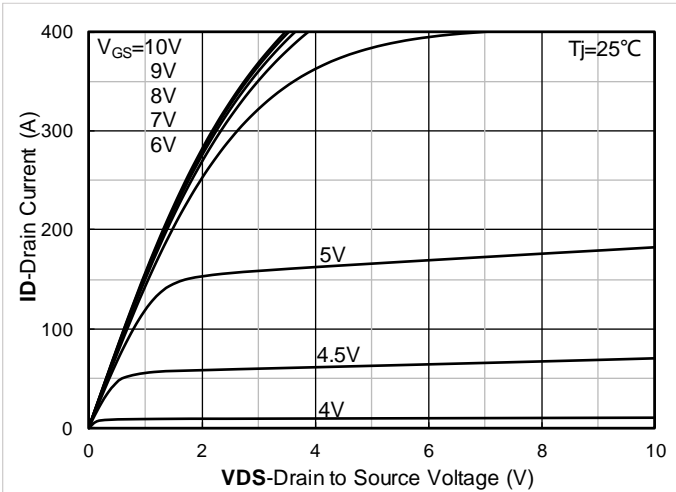

Figure 1. Output Characteristics

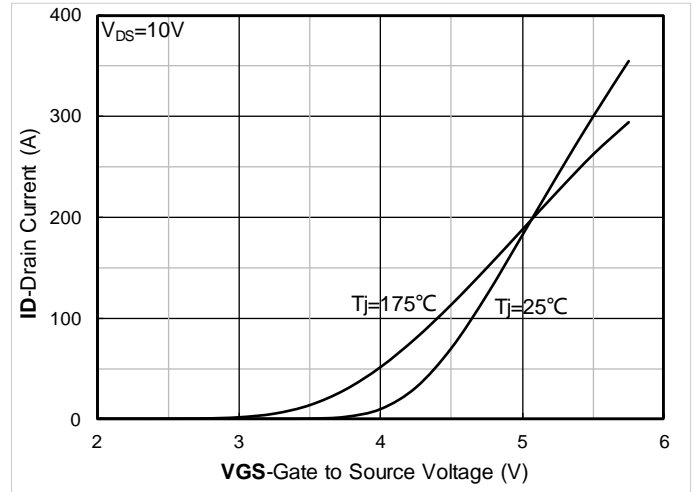

Figure 2. Transfer Characteristics

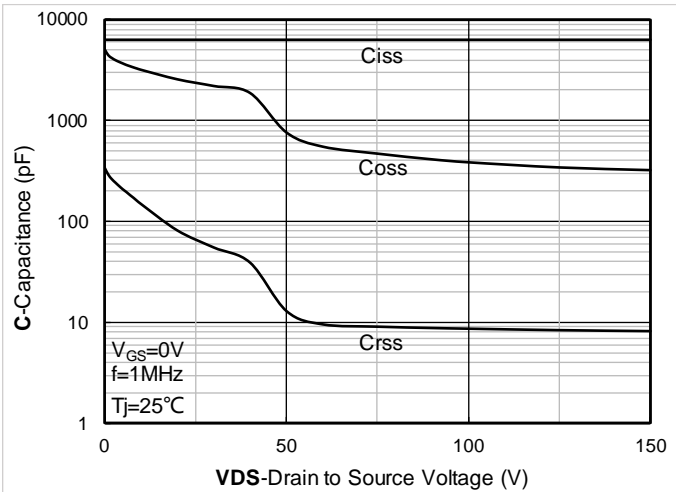

Figure 3. Capacitance Characteristics

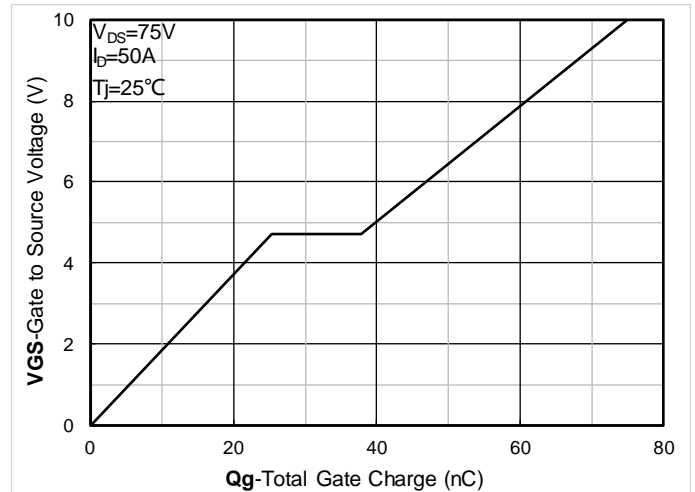

Figure 4. Gate Charge

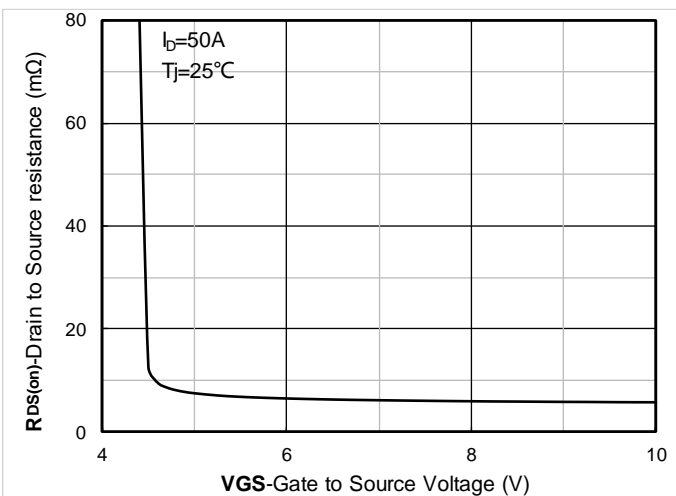

Figure 5. On-Resistance vs Gate to Source Voltage

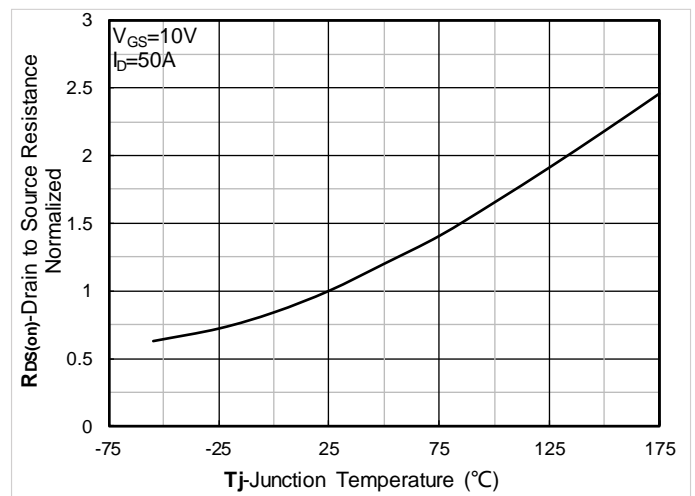

Figure 6. Normalized On-Resistance



YJB6D8G15H

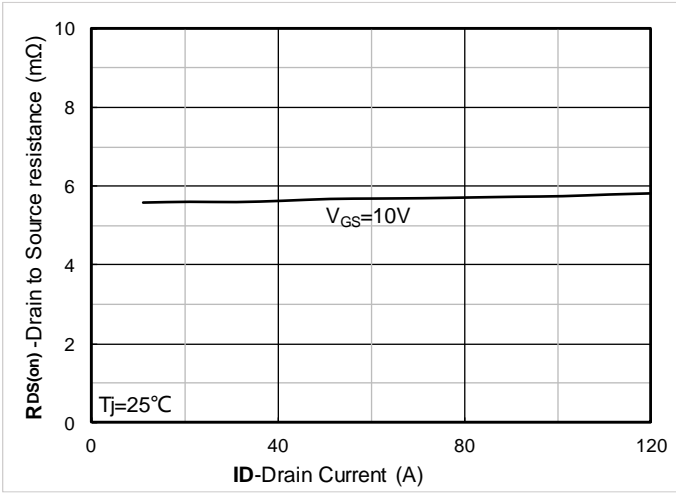

Figure 7. RDS(on) VS Drain Current

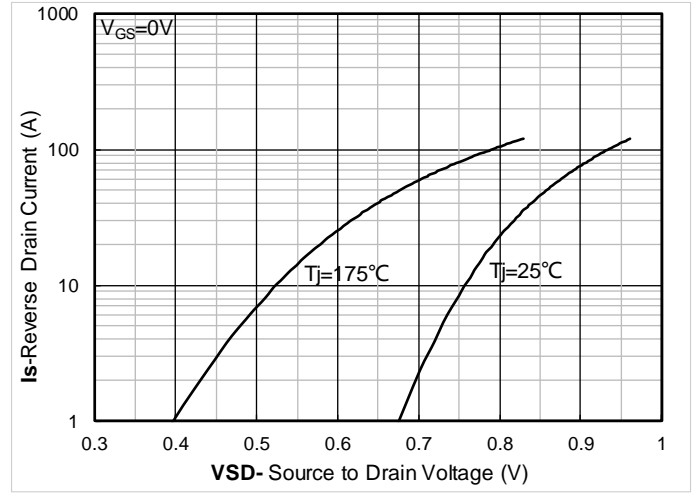

Figure 8. Forward characteristics of reverse diode

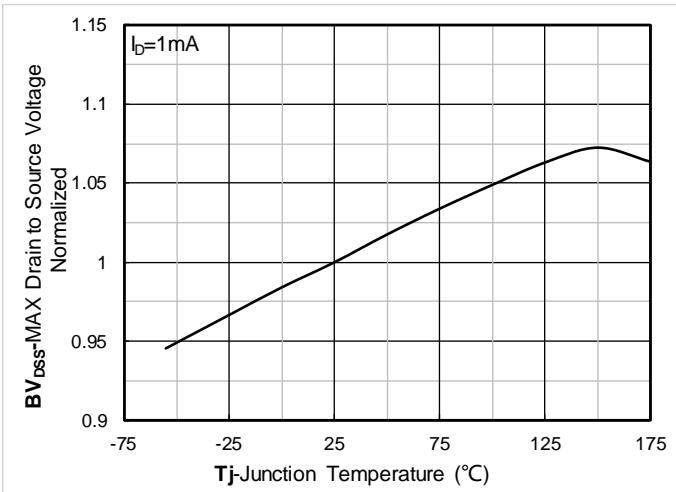

Figure 9. Normalized breakdown voltage

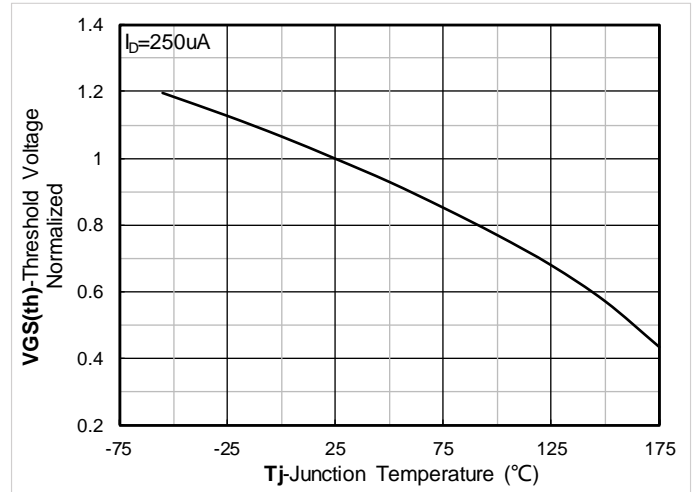

Figure 10. Normalized Threshold voltage

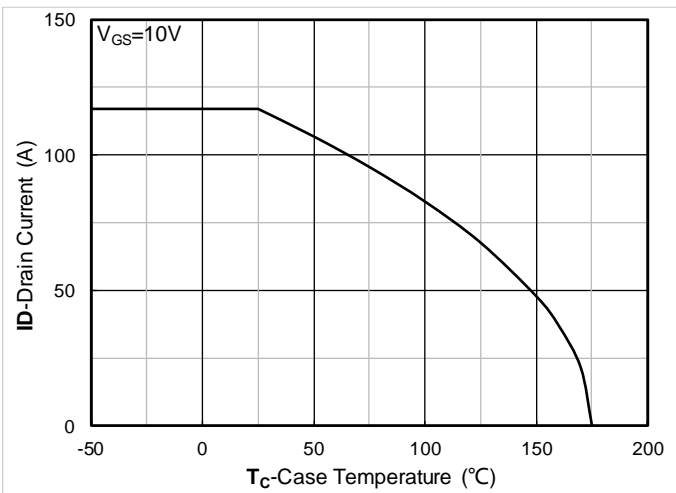

Figure 11. Current dissipation

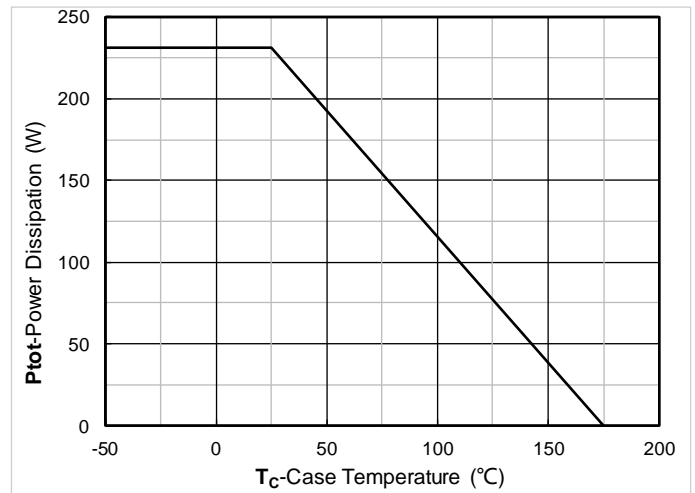

Figure 12. Power dissipation

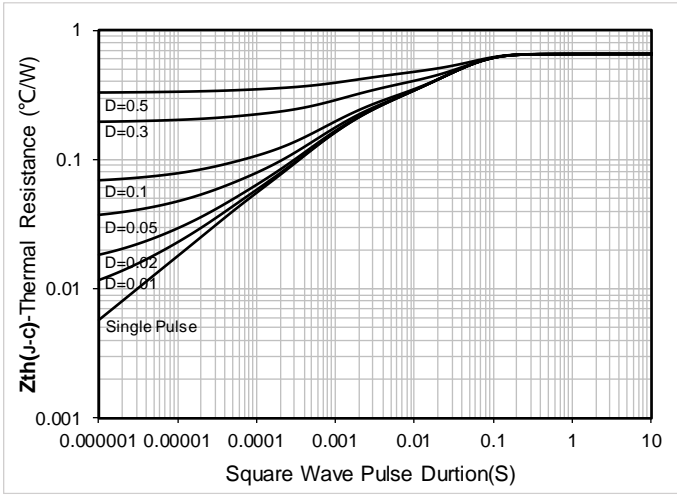

Figure 13. Maximum Transient Thermal Impedance

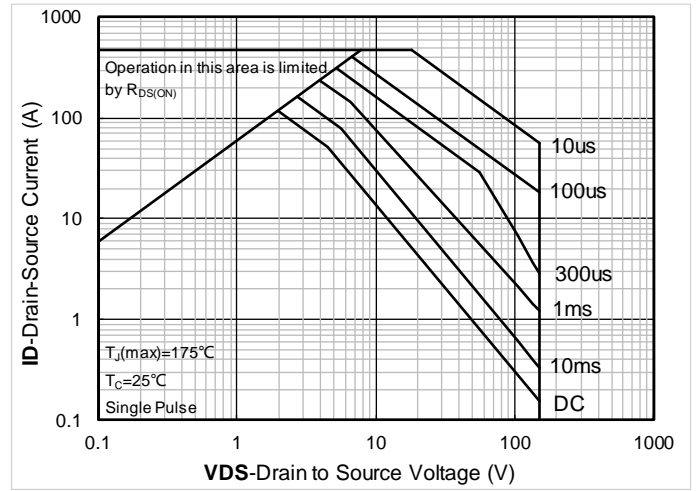

Figure 14. Safe Operation Area

■ Test Circuits & Waveforms

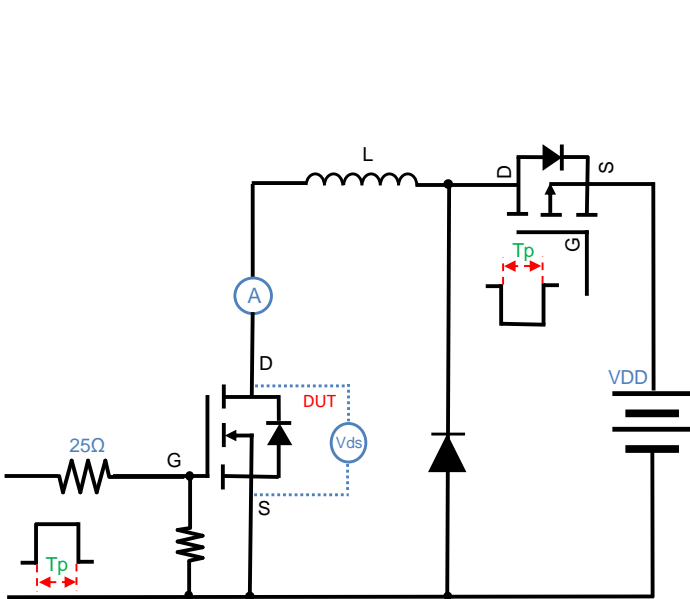

Figure A. Unclamped Inductive Switching (UIS) Test Circuit & Waveform

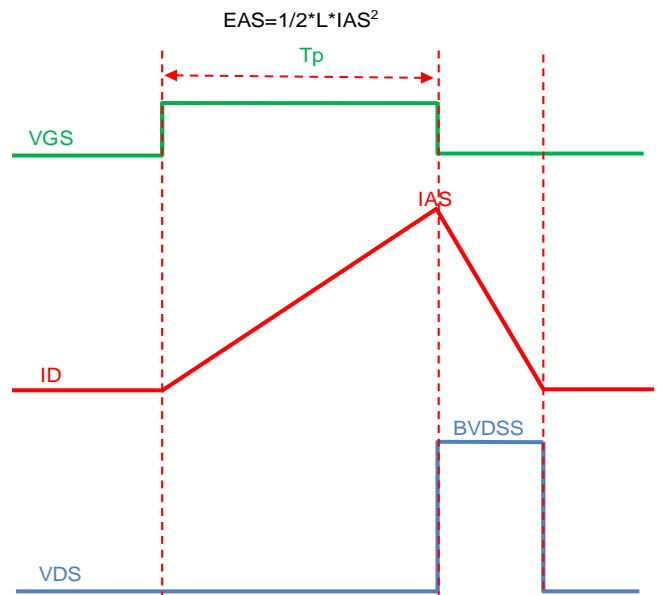



Figure B. Gate Charge Test Circuit & Waveform



Figure C. Resistive Switching Test Circuit & Waveform

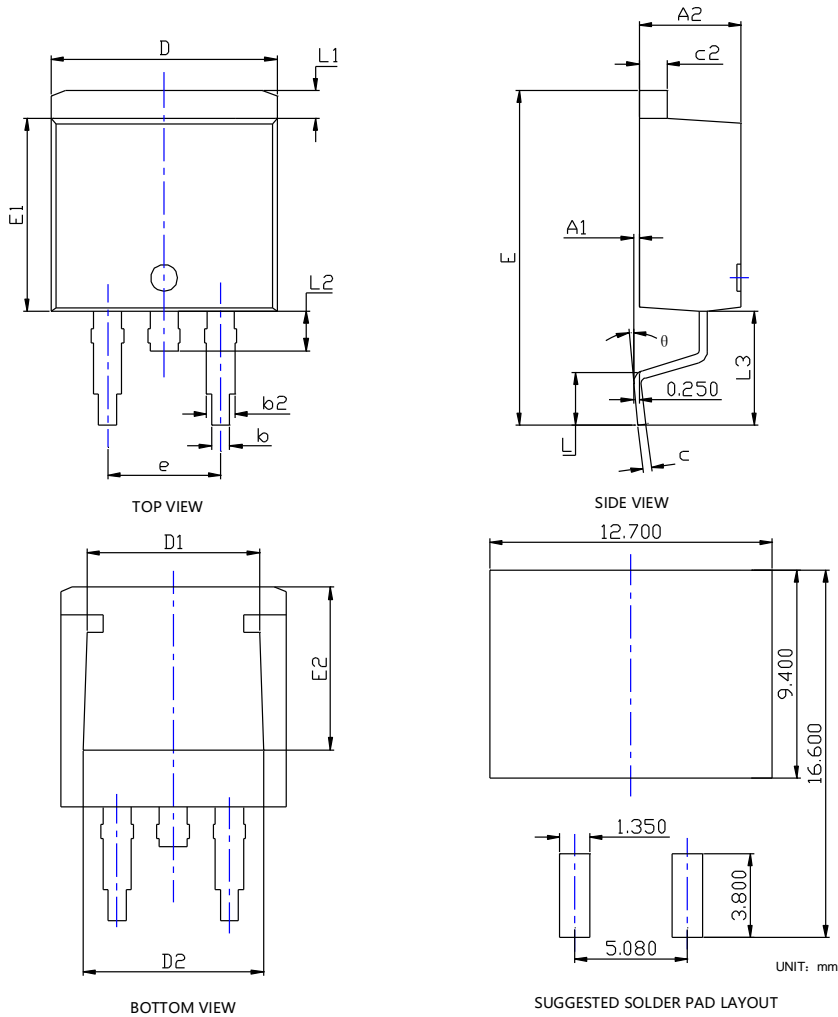

Figure D. Diode Recovery Test Circuit & Waveform



YJB6D8G15H

■ TO-263-HY Package information



SYMBOL	DIMENSIONS					
	INCHES			Millimeter		
	MIN.	NOM.	MAX.	MIN.	NOM.	MAX.
A1	0.000	---	0.010	0.000	---	0.250
A2	0.174	0.180	0.186	4.430	4.580	4.730
b	0.028	0.032	0.036	0.720	0.820	0.920
b2	0.046	0.050	0.054	1.180	1.280	1.380
c	0.013	0.015	0.018	0.330	0.390	0.450
c2	0.048	0.050	0.053	1.220	1.280	1.340
D	0.394	0.400	0.406	10.000	10.150	10.300
D1	0.295	0.307	0.319	7.500	7.800	8.100
D2	0.303	0.315	0.327	7.700	8.000	8.300
E	0.571	0.591	0.610	14.500	15.000	15.500
E1	0.337	0.341	0.348	8.550	8.700	8.850
E2	0.276	0.287	0.299	7.000	7.300	7.600
e	0.200BSC			5.080BSC		
L	0.070	---	0.110	1.790	---	2.790
L1	0.044	---	0.056	1.120	---	1.420
L2	0.030	---	0.070	0.770	---	1.770
L3	0.197REF			5.000REF		
θ	0°	---	8°	0°	---	8°

NOTE:

- 1.PACKAGE BODY SIZES EXCLUDE MOLD FLASH AND GATE BURRS.
- 2.TOLERANCE 0.1mm UNLESS OTHERWISE SPECIFIED.
- 3.THE PAD LAYOUT IS FOR REFERENCE PURPOSES ONLY.



YJB6D8G15H

Disclaimer

The information presented in this document is for reference only. Yangzhou Yangjie Electronic Technology Co., Ltd. reserves the right to make changes without notice for the specification of the products displayed herein to improve reliability, function or design or otherwise.

The product listed herein is designed to be used with ordinary electronic equipment or devices, and not designed to be used with equipment or devices which require high level of reliability and the malfunction of which would directly endanger human life (such as medical instruments, transportation equipment, aerospace machinery, nuclear-reactor controllers, fuel controllers and other safety devices), Yangjie or anyone on its behalf, assumes no responsibility or liability for any damages resulting from such improper use of sale.

This publication supersedes & replaces all information previously supplied. For additional information, please visit our website <http://www.21yangjie.com> , or consult your nearest Yangjie's sales office for further assistance.